



Power*Tools for Windows

Version 7.0

Enhancement List



simplifying

Power Systems

www.ceerelays.co.uk

Electrical Engineering Software

- ◆ **DAPPER® *Integrated Electrical Analysis Software***
Comprehensive Three Phase and Unbalanced Short-Circuit Studies, Load Flow Study, Demand Load Study, Feeder and Transformer Sizing Study, Impact Motor Starting Study, and Load Schedules.
- ◆ **CAPTOR® *Time-Overcurrent Coordination***
Graphical Time-Overcurrent Coordination. Integrated with one-lines, short-circuit modules, Equipment Evaluation, and Arc Flash. Comprehensive protective device library.
- ◆ **ARC FLASH EVALUATION**
Calculates the incident energy and arc flash boundary for each bus in the system. Trip times are automatically determined from the protective device settings and arcing fault current values. Incident energy and arc flash boundaries are calculated based on accumulated fault values. Clothing requirements are specified from a user-defined clothing library. Clearing times can be reduced based on current-limiting capabilities. Complies with OSHA, NFPA 70E, NEC 110.16, and IEEE 1584 requirements. Generates custom labels and work permits. *Also available as ArcCalc, a simplified stand-alone Arc Flash calculator.*
- ◆ **A_FAULT *ANSI Short-Circuit Study***
Three Phase and Unbalanced Short-Circuit based on the ANSI/IEEE C37 Standards. Separate solutions for low, medium and high voltage systems and for symmetrical, momentary and interrupting calculations.
- ◆ **IEC_FAULT *IEC Short-Circuit Study 909 or 363***
Three Phase and Unbalanced Short-Circuit Study based on the IEC 60909 or IEC 61363 Standards.
- ◆ **EQUIPMENT EVALUATION *Equipment Evaluation Report***
Automatically compares short-circuit ratings, withstand ratings. Applies de-rating adjustments and user defined pass/ marginal/failed criteria. Includes error checking for input data and topology.
- ◆ **TMS *Transient Motor Starting Simulation***
Time-based motor starting simulation with graphical output. Includes reduced voltage and capacitor starting, graphical motor and load models.
- ◆ **HI_WAVE *Harmonic Investigation and Filter Design***
Frequency Scan, Harmonic Current, Voltage Distortion, Harmonic Load Flow and Interactive Filter Design.
- ◆ **UNBALANCED/SINGLE PHASE STUDIES**
Load flow, short-circuit, demand load analysis, sizing, and load schedules. Reports single-phase loads and unbalanced operating conditions including phase and sequence currents and voltages.
- ◆ **I*SIM *Dynamic Simulation and Transient Stability***
Dynamic Response to Power System Electro-Mechanical Disturbances, Generator Sizing and Stability, Flux Level Machine Representation. User Defined Graphical Models for Exciter, Turbine Governor, PSS, and other controllers.
- ◆ **DISTRIBUTION RELIABILITY *Reliability Analysis***
Calculates the reliability indices of individual load points and the overall distribution systems with either radial or loop configuration. Includes Load Point MTTF, Failure/Year, MTTR, Annual Outage, EENS, ECOST, and other IEEE indices. Cost-related factors and aging factors are included in the analysis to compare alternative designs.
- ◆ **DC SYSTEMS ANALYSIS**
Battery Sizing, Load Flow, & Short Circuit Analysis. Evaluate all loading conditions for DC duty cycle loads and AC emergency loads. Complies with IEEE std. 485, 1115, 399, 946, and IEC std. 61660.
- ◆ **GROUND MAT *Substation Ground Grid Design and Analysis***
Optimizes grid design using general purpose finite element algorithm for potential analysis and graphical facilities to validate grounding systems efficiency.
- ◆ **IEE Wiring regulation Sizing**
Integrates the rules and data tables from the IEE Wiring Regulation to size cables based on the design loads of the power system. Automatically select the correct table from the IEE Wiring Regulation and pick the proper cable size.
- ◆ **CABLE-3D**
Solves complex three-dimensional cable pulling tension and sidewall pressure calculations.
- ◆ **PTW VIEWER**
Read-only version of PTW for displaying, printing, and exporting all study results. Create or expand one-lines and apply datablocks. View Time-Current Curves. View and create customized Arc Flash Labels and Work Permits.

Arc Flash Evaluation

1. NFPA 70E 2012 edition updates implemented. Updated Arc Flash Label Styles, PPE Table, and others to be compliant with the new standard.
2. DC Arc Flash based on NFPA 70E 2012 Annex D.8.1.1.
3. NESC 2012 edition updates implemented. Tables 410, 431, and 441 and incident energy calculations for low voltage (50V-1000V) implemented.
4. New user notes and comments column in the Arc Flash Evaluation results spreadsheet. Notes entered are also available in the Datablock Format under the “AF_Notes (User)” attribute.

Required Protective FR Clothing Category	Label #	Cable Length From Trip Device (ft)	Incident Energy at Low Marginal	Incident Energy at High Marginal	User Notes
--	---------	------------------------------------	---------------------------------	----------------------------------	------------

5. Arc Flash “Notes” from the main spreadsheet are now stored in the database for Datablocks.

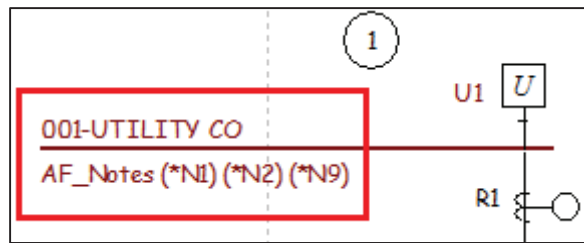

6. Enhanced the Arc Flash report to include the library device name if the device is not linked to a library or missing.

Bus Name	Protective Device Name	Bus kV	Bus Bolted Fault (kA)	Prot Dev Bolted Fault (kA)	Prot Dev Arcing Fault (kA)	Trip/ Delay Time (sec.)	Breaker Opening Time/Tol (sec.)	Ground	Equip Type	Gap (mm)	Arc Flash Boundary (mm)	Working Distance (mm)	Incident Energy (J/cm2)	Required Protective FR Clothing Category
T1 SEC	R1 T1	13.80	3.86	3.44	3.39	1.917	0.083	Yes	SWG	153	6491	914	34	**** Missing TCC Curve (Lib Info: WESTINGHOUSE, CO-11, 50/51, 0.25-0.5/0.5-2.5A, 418267) (*N9)

7. Improved the Arc Flash PPE Table to allow entering a percentage to be used as a high and low threshold value for the Low and High Marginal Incident Energy columns. The threshold values can also be overwritten manually in the PPE Table.

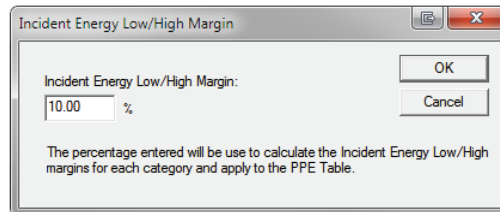

- Labeling of the Arc Flash Arcing Current Line on TCC drawings to show the worst case, arcing current in amperes, and the associated bus location.

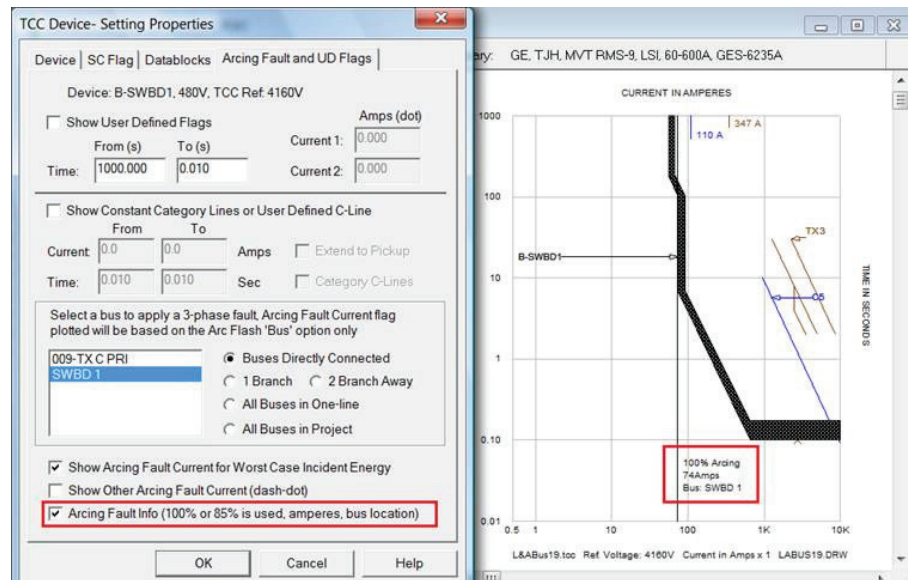

- Enhanced the Arc Flash Evaluation by appending the function name to a protective device name if multiple functions exist.
- Arc Flash study options are now stored in the Project Options menu for current and new projects. Arc Flash study options are now accessible first before the Arc Flash calculations.
- Apply Worst Case Arc Flash Datablock attributes (AFWC_) for buses and protective devices from all or selected project scenarios. Worst Case results include Boundary, Incident Energy, Arcing Current, PPE Category, PPE Description, Working Distance, and Scenario Name.
- Ability to define all Arc Flash Evaluation study options for new projects.
- Display arc flash distances in both English and Metric units on labels.
- Option to complete Arc Flash Evaluation on Buses, Protective Device Line Side, and Protective Device Load Side simultaneously. Worst Case can be reported for Bus + Protective Device Line Side or Bus + Line Side + Load Side.

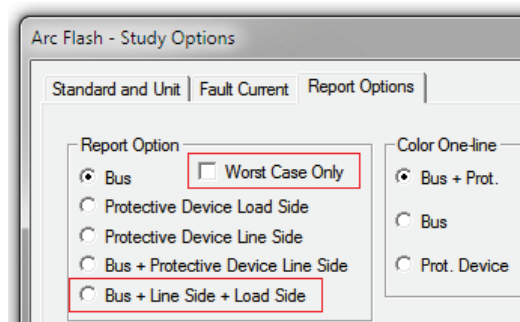

15. Dangerous Arc Flash results will be indicated in the Equipment Evaluation interface for protective devices and buses.

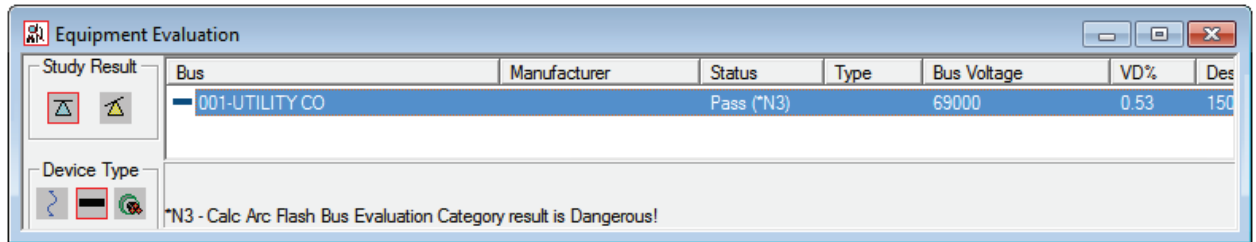

16. Reclosers now have “Curve Multipliers” that are saved with the device and used in Arc Flash calculations to determine the trip time. The entire recloser curve will be updated and the new curve will be used within Arc Flash.

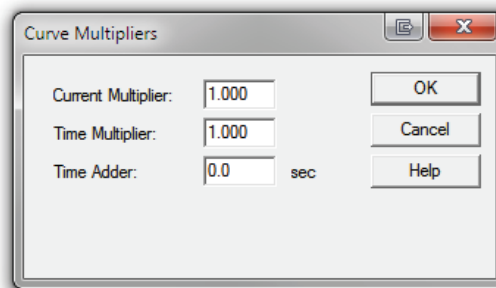

17. Equipment Evaluation notes in the Arc Flash Spreadsheet if a device fails or is marginal as determined by the Equipment Evaluation study module. (*N20 for Marginal and *N21 for Failed). This does not necessarily mean that the Equipment is dangerous, but it is possible depending on the circumstances.
18. User-definable Glove Class table. Allows specifying custom glove classes based on voltage levels on Arc Flash labels.
19. Option to exclude the Main Device (the protective device with the most arcing current when there are multiple contributions to the faulted bus). This is used to test the case where the Main Device fails to operate. The software will use the upstream devices for the arc flash calculations instead.
20. “Go To” feature for a single bus now includes launching both the Arc Flash spreadsheet window and a TCC drawing plotting the summary device where the fault threshold is cleared.

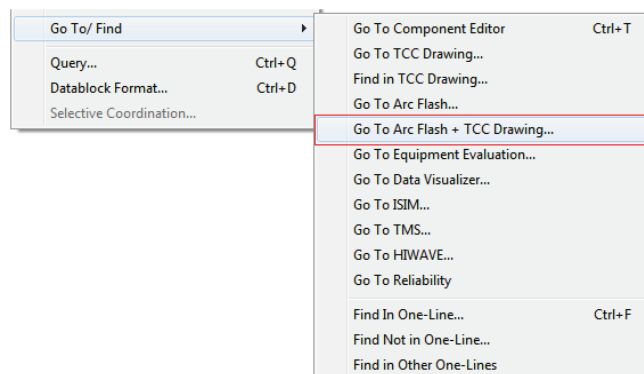

21. Automatic layout button in TCC drawings will launch Arc Flash for the selected bus and will fit the available screen space.

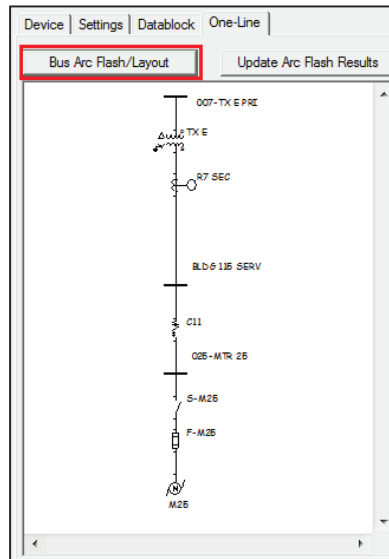

22. Maintenance mode - If maintenance mode function is checked in the arc flash setup, main devices (the protective device with the most arcing current when there are multiple contributions to the faulted bus) that has maintenance mode function enabled in the protection function window will be used in the arc flash evaluation.

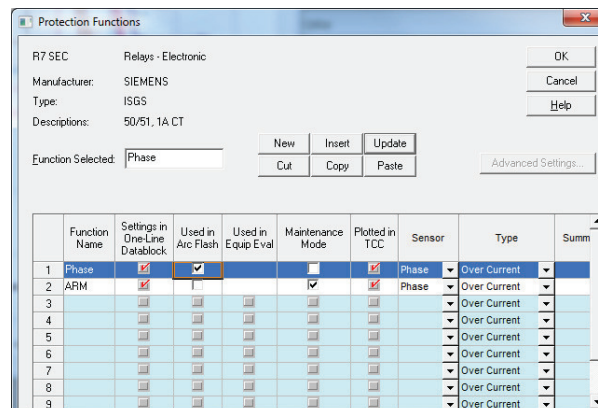

23. “Breaker Opening Time” renamed to “Breaker Opening Time & Tolerance”.

CAPTOR

1. Protective device Function Toggle button in the Component Editor and TCC interface to quickly switch between functions.

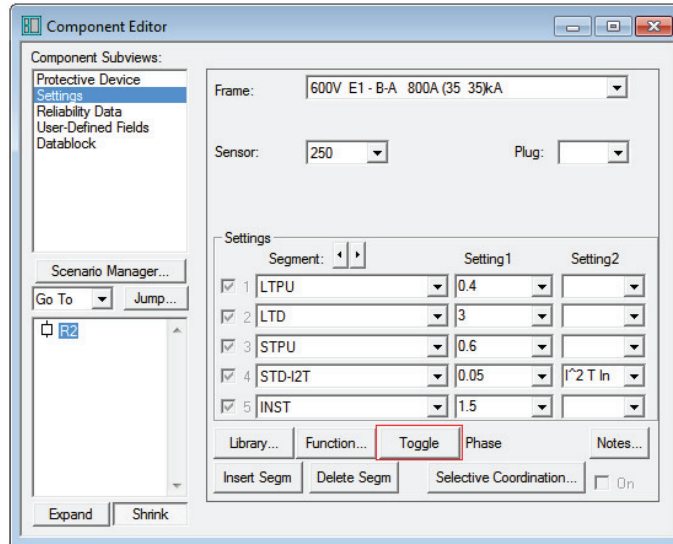

2. Change color of all non-protective devices to black in TCC drawings. Setting available for new projects, Global Change (all TCC drawings), and individual TCC settings.

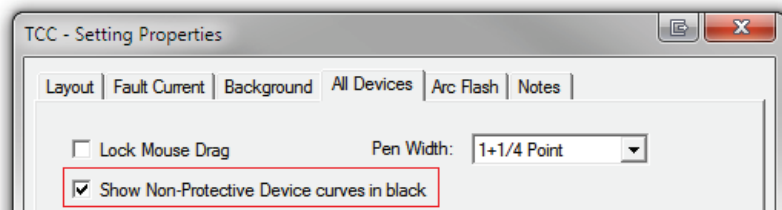
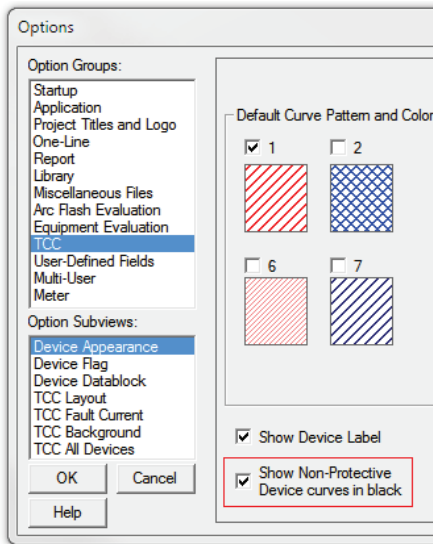

3. Customized generator decrement curve can be plotted from the generator component editor. Generator Decrement models provided includes Kohler 7M4050 and Newage MV824D. Include ability to unlink from the library to enter user-defined values.

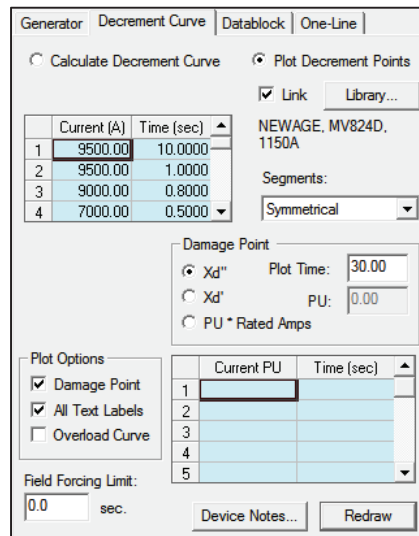

4. Transformer FLA marker, damage curve, inrush point/curve is now based on the Transformer Base (FLA or Nominal).
5. User-definable Transformer Damage Curve.

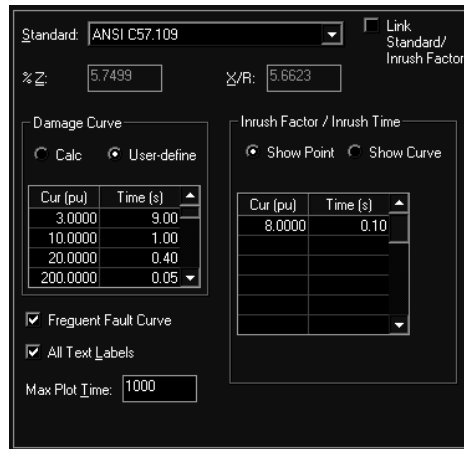

6. "Go To TCC" feature now includes option to use a pre-defined voltage as the reference scale in the Project Options menu.

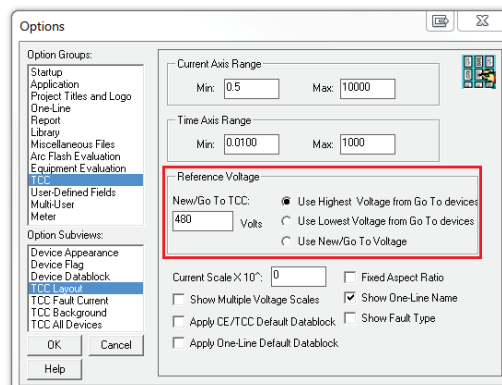

7. New TCC report that lists all TCC drawing names along with the names of all equipment in the TCC drawing. Also includes function to “Update TCC Names function in Component Editor/TCC”. (TccNames attribute)
8. New curve segment type where each data point can have a different slope. While the function is similar to the existing Delay Band ($I \wedge \text{Slope} - T$) with Open – Clear Time in Seconds segment, the new segment slope is based on a constant and not a pickup value.

10%			
	Open	Clear	k
Min-F	0.65	1.45	5
F-2	1.94	4.34	15
F-3	3.50	7.81	27
F-4	5.44	12.15	42
F-5	7.78	17.35	60
F-6	10.89	24.29	84
F-7	14.64	32.68	113
F-8	19.31	43.09	149
F-9	25.14	56.11	194
F-10	32.53	72.59	251
F-11	41.73	93.12	322
F-12	53.14	118.57	410
F-13	67.52	150.68	521
F-14	85.41	190.59	659
F-15	107.83	240.62	832
F-16	135.95	303.38	1049
F-17	170.94	381.46	1319
F-18	214.75	479.21	1657
F-19	269.44	601.26	2079
F-20	337.87	753.96	2607
F-21	423.53	945.12	3268
Max-F	518.40	1,156.82	4000

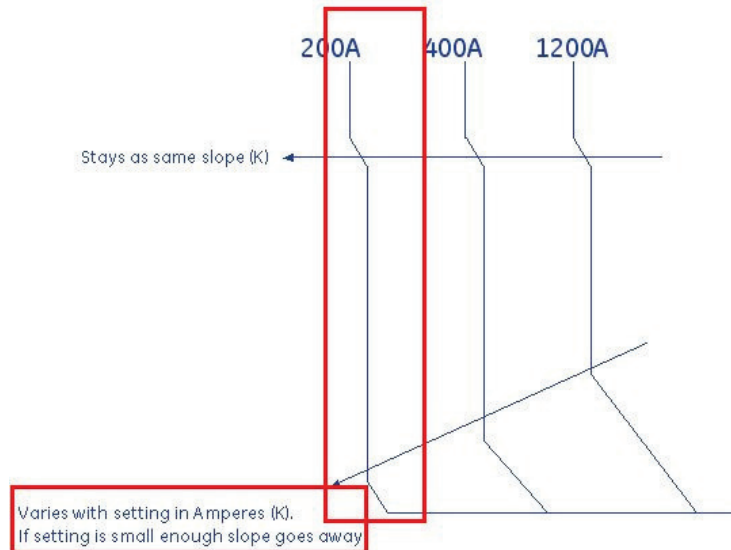

9. New options added to the Global Change feature to include “Use last applied TCC Datablock format name for all TCCs”, “Use last applied one-line Datablock format name for associated one-lines”, etc.

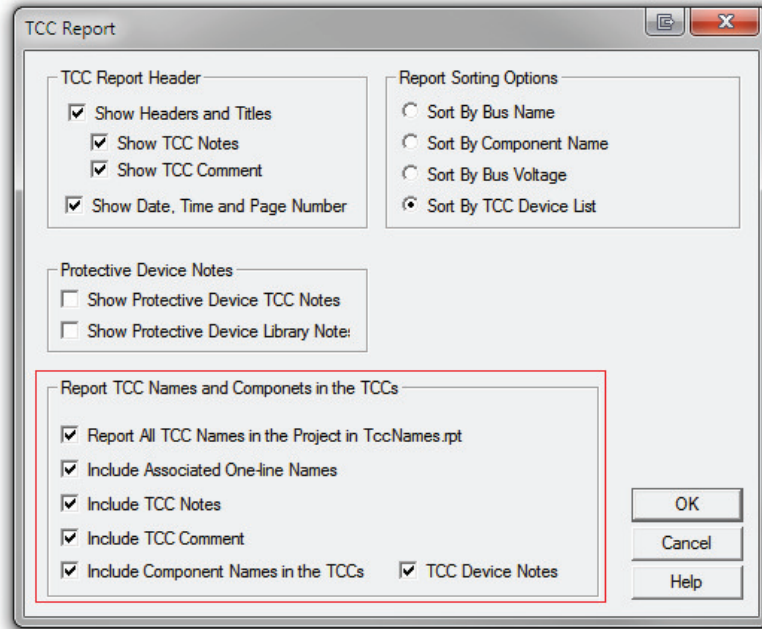

10. Last applied Datablock format will now be copied to a cloned TCC drawing.
11. Utility and Impedance Tolerance in the TCC Settings Options.

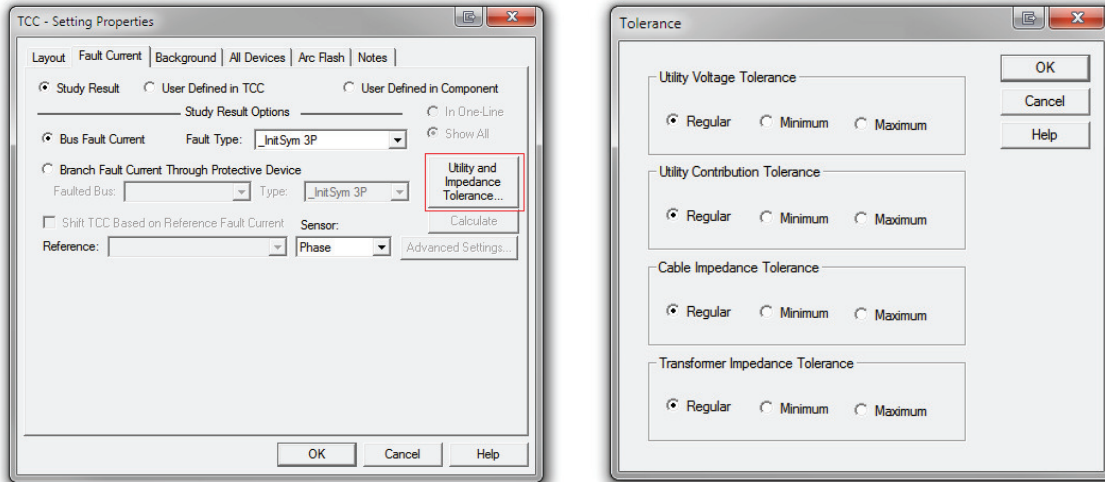

12. New Datablock attribute to display all the TCC drawing names where a particular component exists. (TccNames attribute)

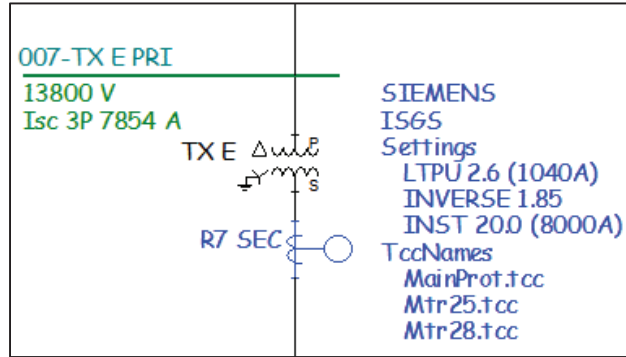

13. Function to update TCC drawing names attributes that is being displayed. (TccNames attribute)
14. Set TCC drawing textblock fonts as a default and used when new textblocks are created in TCC drawings.

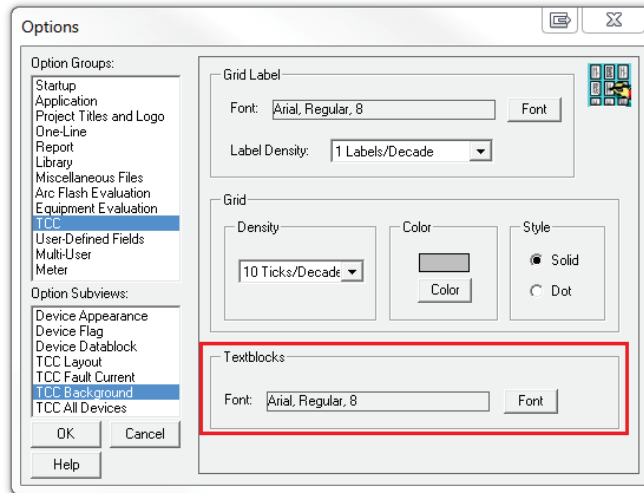

15. Apply default Datablocks to Component Editor, TCC drawings, and associated one-lines. This allows displaying Datablocks automatically without enabling it each time.

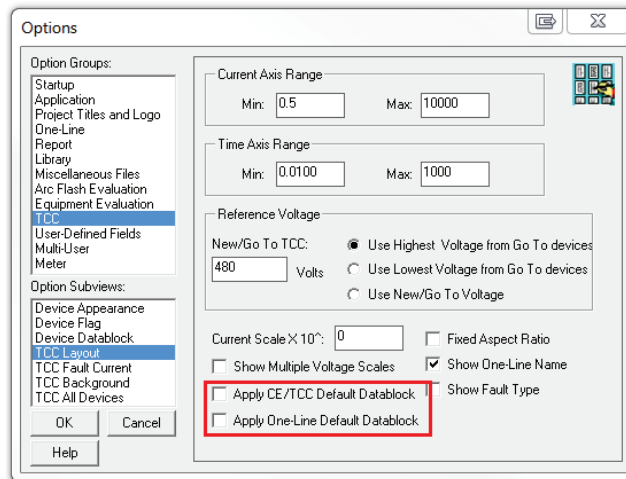

16. Show Bus Fault Type and Branch Fault Type & Location for TCC drawings and in the Form Print Title Block area (TCC Fault Type/Location (TCC Area)).

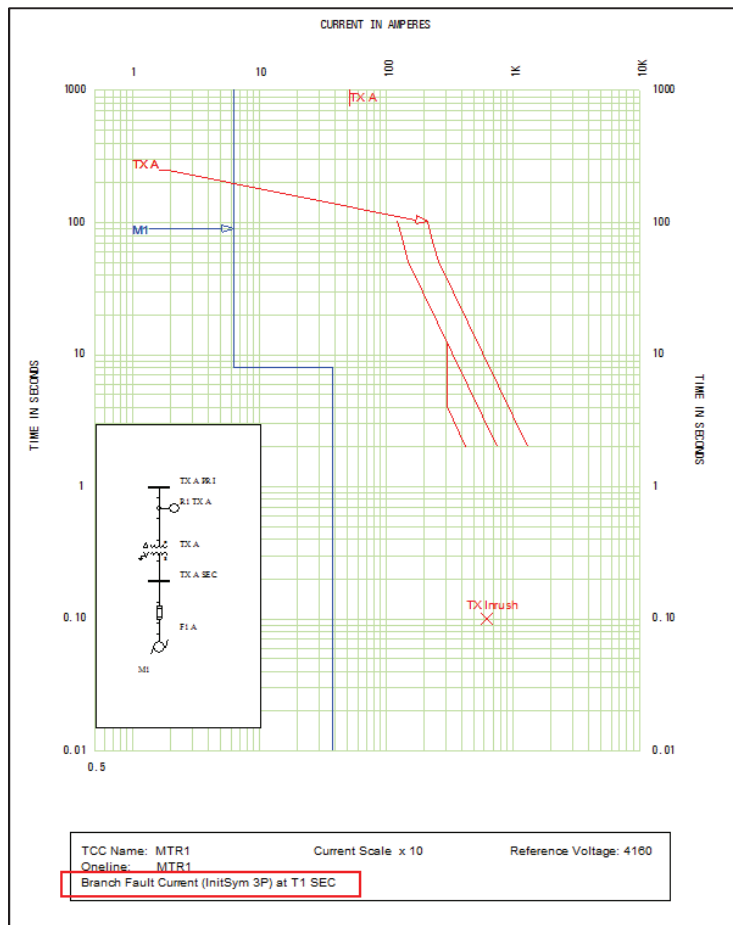
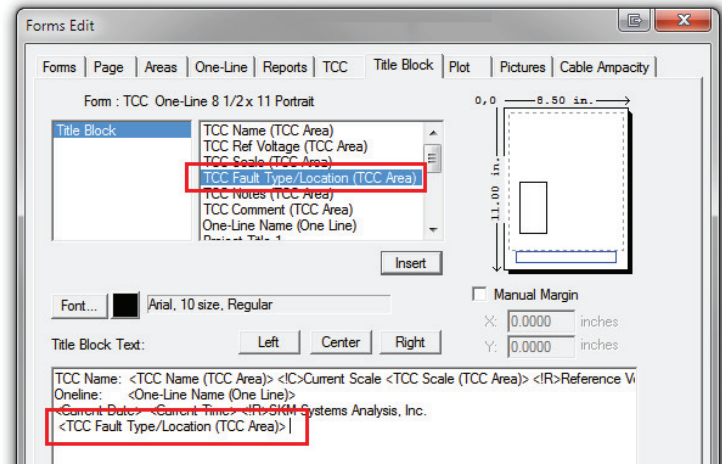

- 17. Feature to delete a one-line drawing associated with a TCC drawing when the TCC drawing is being deleted.
- 18. New options added to the Global Change dialog window.

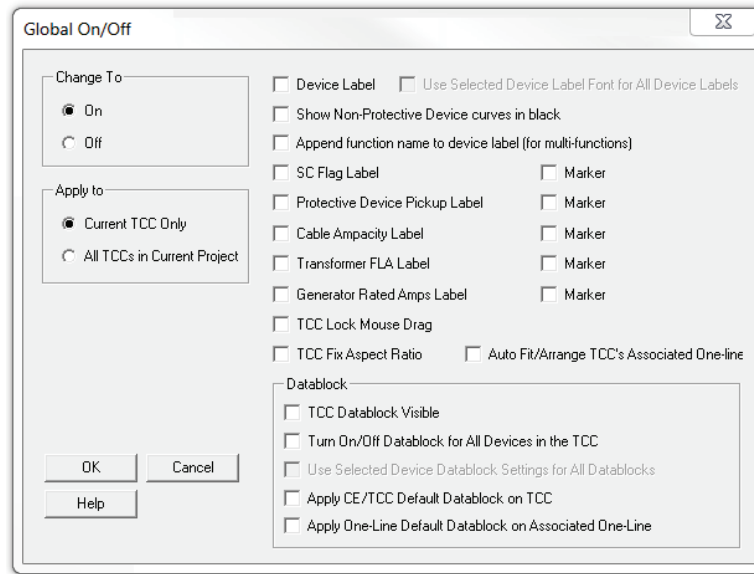

General Modeling

1. Closed Transition Automatic Transfer Switch (ATS) added. For Closed Transition ATS type, the line terminals are closed during the transition and represent zero impedance between the 2 line terminals for a SC study.

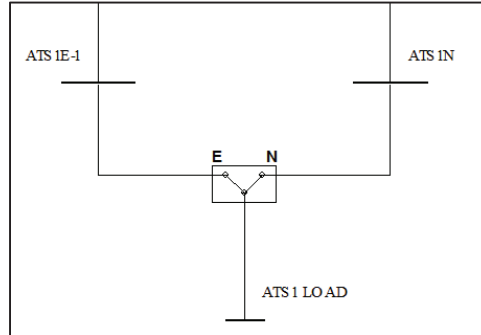

2. Customizable ATS switch position labels for the Emergency and Normal positions:

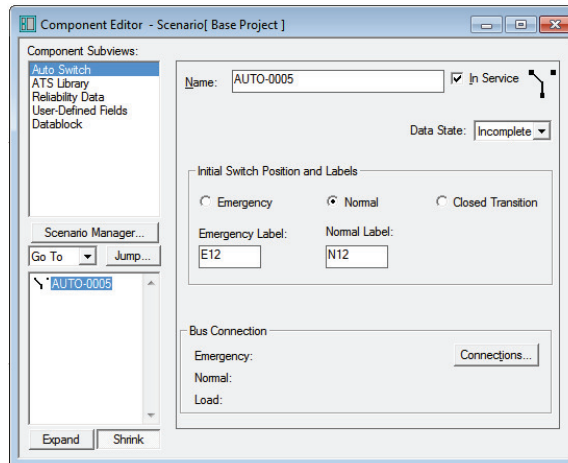

3. Transformer LTC Master/Slave feature. The Slave Transformer's tap setting will be changed to the Master Transformer's tap setting after it has been automatically adjusted during the load flow study.

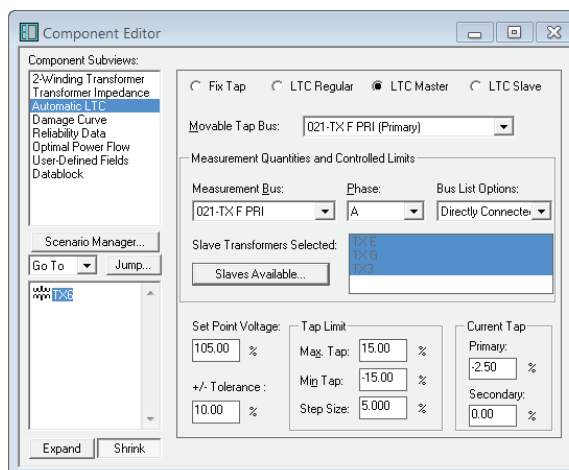

- Reliability Component Editor sub-view added for the Automatic Transfer Switch (ATS) component.

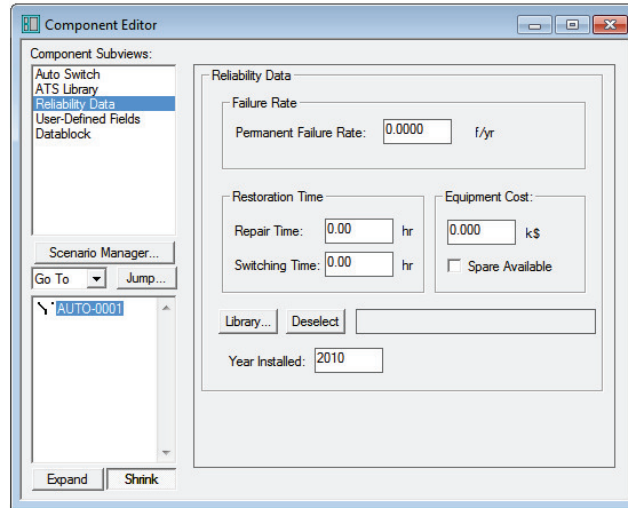

- Modeling of zero sequence impedance for YG/YG Core Type transformers by using a new ZH field. (The data entered in this field determines the impedance on the high side of the transformer in terms of the total impedance. This field is only available for 2-winding YG/YG core type transformers. The picture below shows the impedance diagram. In the picture below, the 1st, 2nd, 3rd, and 4th columns are "transformer connection", "positive & negative sequence", "zero sequence" and "approx. zero sequence".)

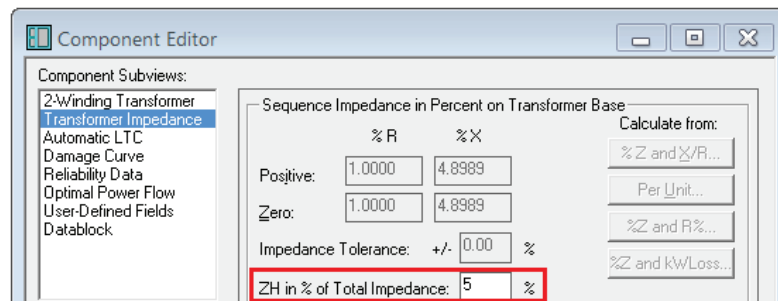
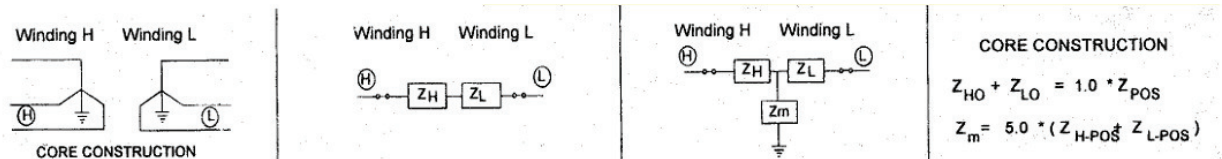

- New Transformer Connections for Zig-Zag and Grounding Zig-Zag. (These are normally used to mitigate harmonics. Impedance diagram of Zigzag, and Zigzag-Ground connections are the same as Wye and Wye-Ground respectively.)

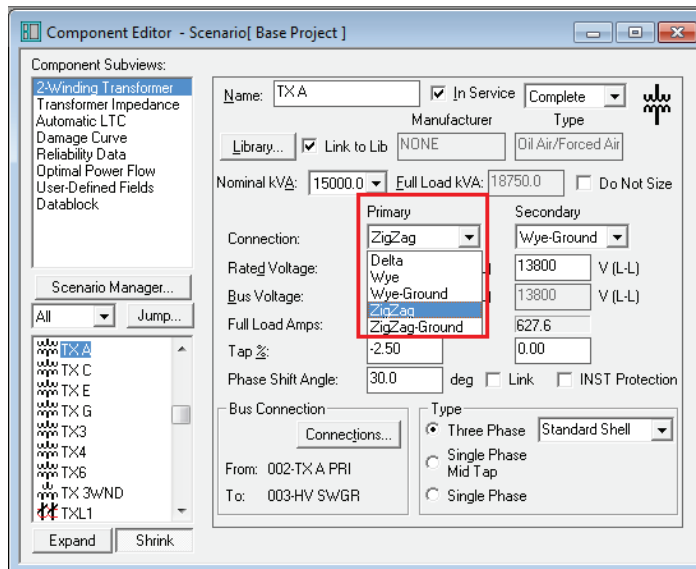

- New Corner-Grounded type transformer. Supported in Unbalanced Studies only. (For Corner-Grounded, the primary connection can be set as Delta, Y, or YG. The secondary connection is set to Delta. Phases A, B, or C can be set to be solidly grounded.)

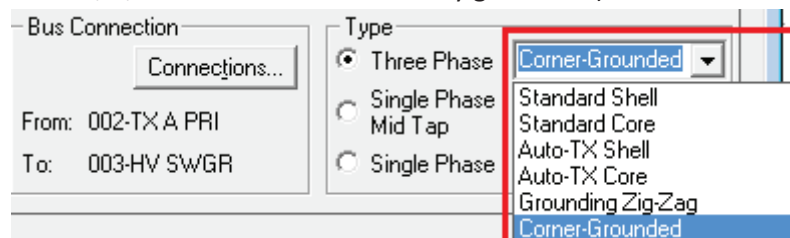

- New transformer impedance, cable impedance, utility voltage and contribution tolerance fields. This allows using the maximum impedance tolerance combined with the minimum utility contribution to run a minimum fault study without having to create a new scenario. These tolerances can be applied when running a Load Flow or Comprehensive Short Circuit study.

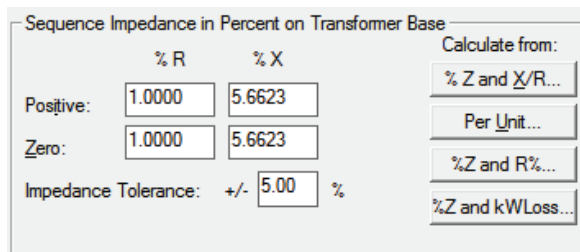

- Link with Contribution for Generators. When enabled, Xd''sat, Xd'sat, Xdsat, Td'' and Td' data will be copied from the SC Contribution page. (The IEC Contribution data has more direct relation with the Decrement page data. When the ANSI Contribution is displayed (Project Option Standard is set to ANSI), PTW converts the contribution page from ANSI to IEC, then copies over to the Decrement page.)

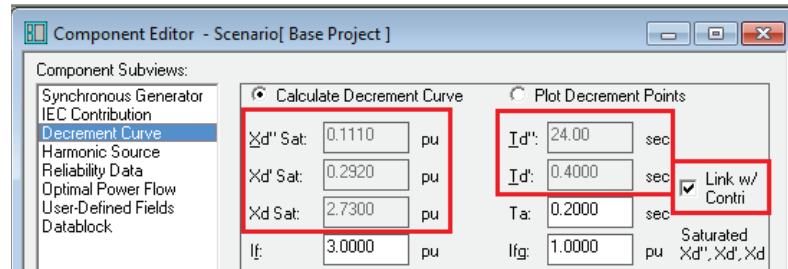

- Option to select 30 or 14 character limit for component names.

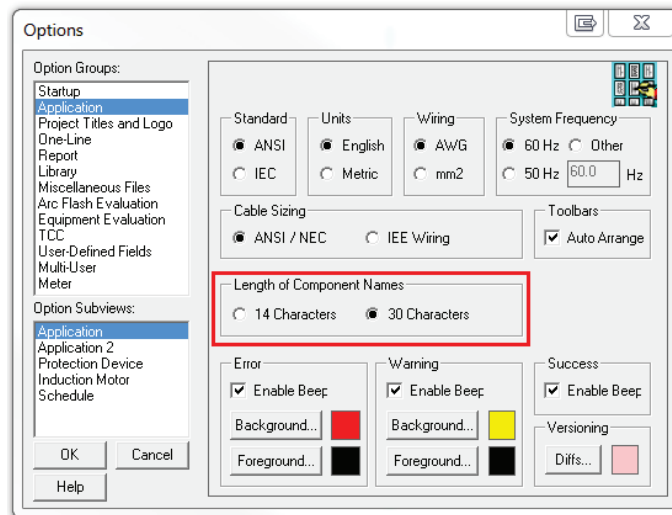

- Feature to promote components, one-line drawings, TCC drawings, and study cases to selected scenarios.

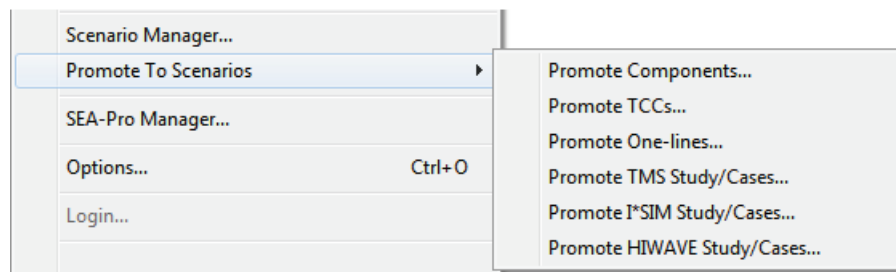

- New Datablock Format attributes, such as displaying the ampacity of the secondary side of a two-winding transformer. Worst Case Arcing Fault, Incident Energy, PPE Category, PPE Description, Scenario Name, etc. attributes are also added to the bus and protective device components.

13. Automatically display study result reports immediately after completing a study.

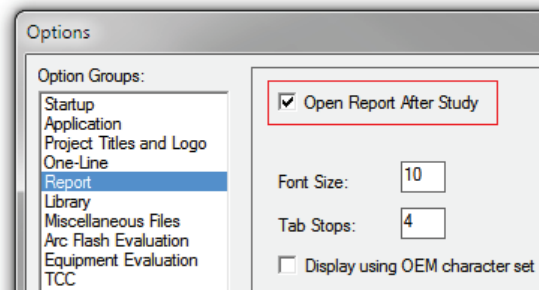

14. Show multiple function settings and CTs for Datablocks.

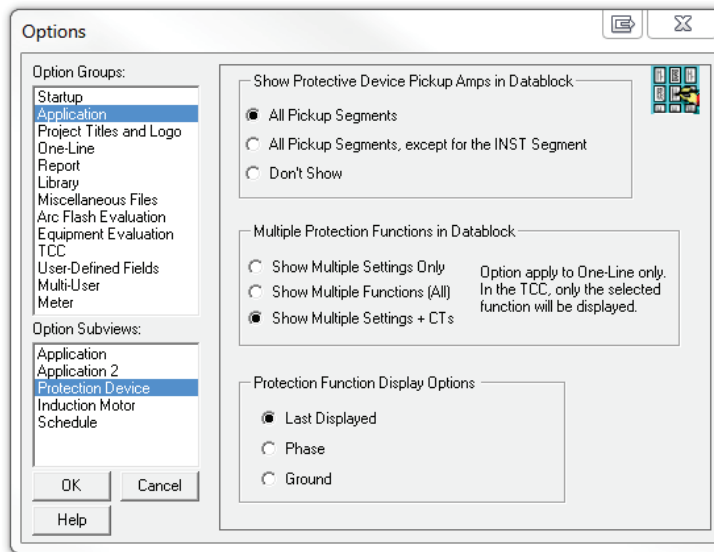

15. New Solar PV and Induction/Wind Generator components. (Automatic kW and kVar calculations.)

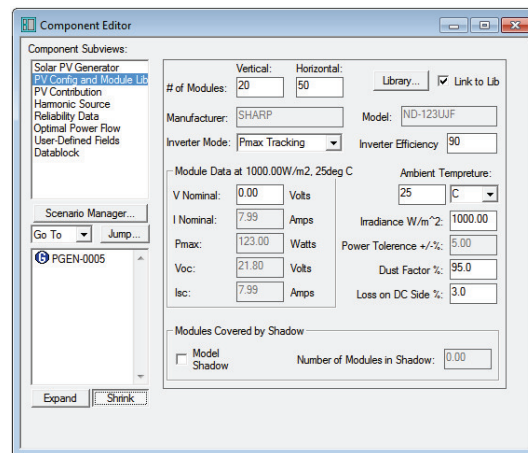
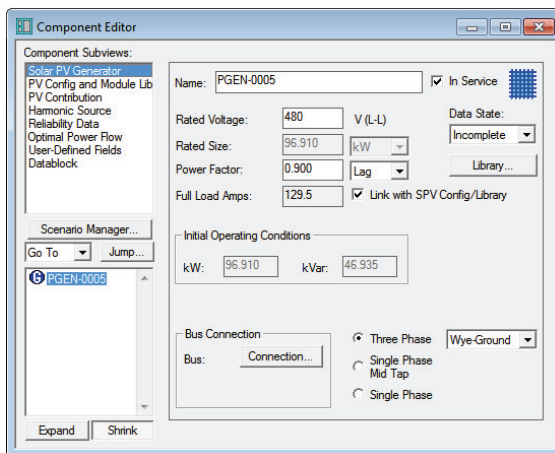

- Solar Photovoltaic Library from various manufacturers, including Sanyo, Sharp, Kyocera Solar, CP-Solar, Bull PowerTech, Solar World, and more.

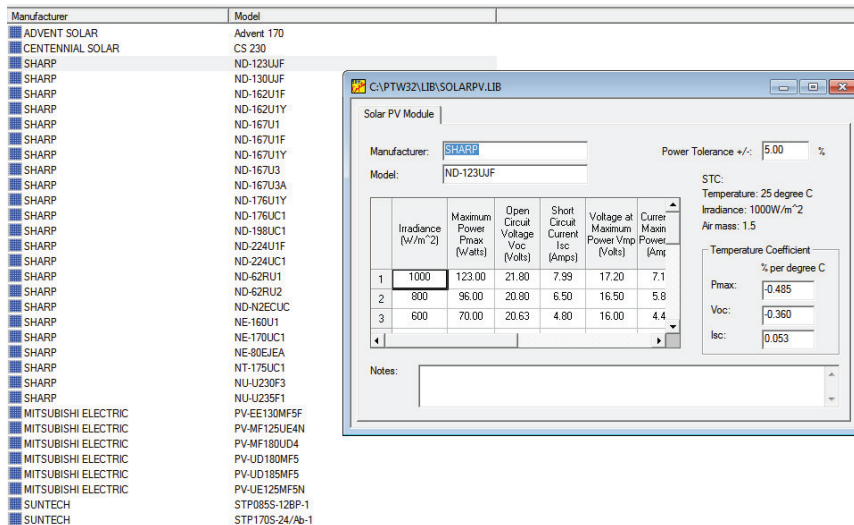

- Store and link the inrush factor with the transformer model library. Ability to override the inrush factor in the Component Editor.
- CT Scaling for differential relays to offset the transformer tap.
- Project merge feature enabled for all scenarios within a project.
- Increased the number of scenarios to 20 for each project.
- Motor nameplate library with motor loading table.
- “Run Studies” button in the Data Visualizer to run studies for scenarios. Saves times by not needing to open each scenario and running the studies to get updated results.
- New Project import/export in XML format. Format is based on the selected Datablock.

Transient Motor Starting (TMS)

- Option to link motor controller component model with motor connected directly to it. If linked, the controller in the TMS/I*SIM Default sub-view of the motor component editor will be grayed out and will have the same model as the motor controller component. This information can then be used in the Motor Starting.

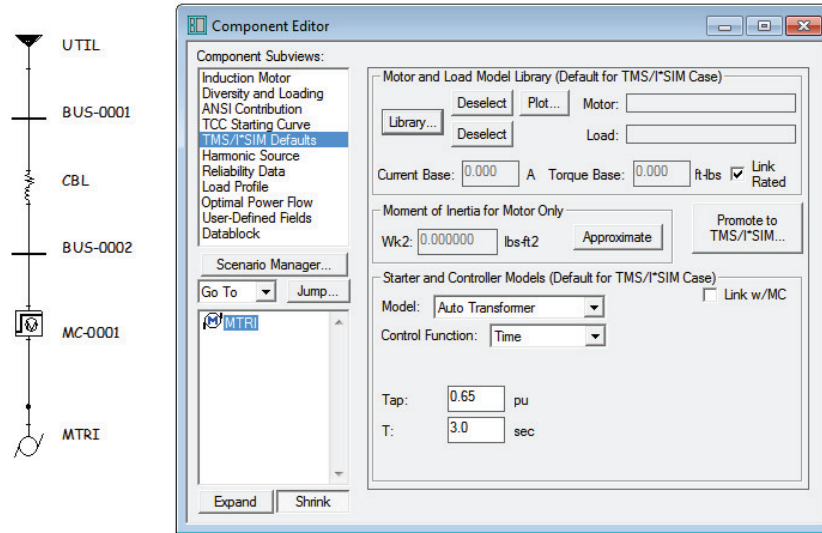

- New Kick Start data added to the Motor Controller in the TMS/I*SIM Component Editor Subview.

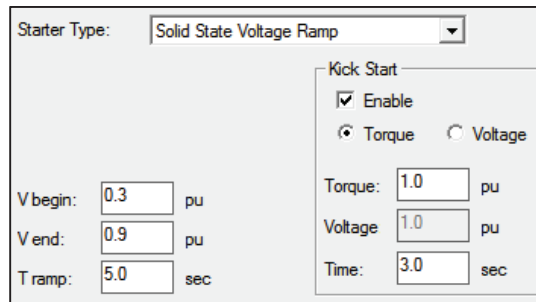

- Liquid Resistance Starter

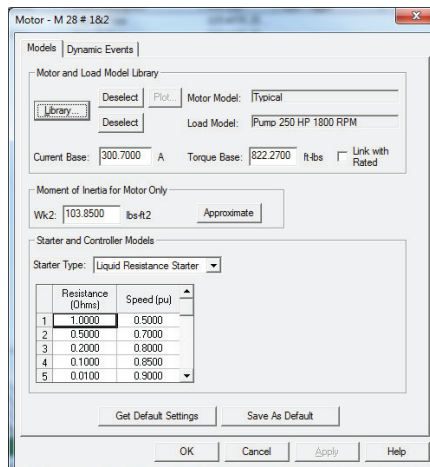

Equipment Evaluation

1. For comprehensive short circuit studies, 3p, SLG, LL, and LLG faults are now included in the evaluation. Previously, only 3p and SLG fault were considered.
2. Option to exclude pi-equivalent networks and tie-breakers from Equipment Evaluation.

HI_WAVE (Harmonic Analysis)

1. New selection in HIWAVE PCC Definition dialog for selecting IEEE 519 1992 and 1996 Draft standards. All PCC options supported by both standards.

Here are the PCC Options:

1. All utilities, generators, and harmonic source buses
2. All utilities and generators buses
3. Selected Buses
4. All Buses

Accuracy

Simplicity

Results

Excellence

Taking **Power Systems Analysis and Design** to New Heights

Since 1972, SKM Systems Analysis Inc. has been the market leader in power systems analysis and design software. With the release of Power*Tools for Windows Version 7.0, SKM has reached newer heights with the most productive software to be released in its 40 year history to the professional engineering community.

New PTW software features accelerate tasks, enhance reporting, increase equipment libraries, improve workflow, add new study options and more to meet challenging industry demands.



SKM

CEE Relays Ltd.
87C Whitby Road
Slough
SL1 3DR
T: +44 1753 576477
F: +44 1753 825661
www.ceerelays.co.uk